



ETA-Danmark A/S  
Göteborg Plads 1  
DK-2150 Nordhavn  
Tel. +45 72 24 59 00  
Fax +45 72 24 59 04  
Internet [www.etadanmark.dk](http://www.etadanmark.dk)

Authorised and notified according  
to Article 29 of the Regulation (EU)  
No 305/2011 of the European  
Parliament and of the Council of 9  
March 2011

MEMBER OF EOTA



## European Technical Assessment ETA-23/0253 of 2023/03/28

### I General Part

**Technical Assessment Body issuing the ETA and designated according to Article 29 of the Regulation (EU) No 305/2011: ETA-Danmark A/S**

**Trade name of the construction product:**

AT-HP / AT-HP PLUS / S&P ResAC-19

**Product family to which the above construction product belongs:**

Bonded injection type anchor for use in concrete:  
sizes M8 to M24, rebar 8 to 25 mm

**Manufacturer:**

Simpson Strong-Tie®  
Rue du Camp  
Z.A.C. des Quatre Chemins  
F-85400 Sainte Gemme La Plaine  
Tel. +33 2 51 28 44 00  
Fax +33 2 51 28 44 01  
Internet [www.simpson.fr](http://www.simpson.fr)

**Manufacturing plant:**

Simpson Strong-Tie®  
Manufacturing Facilities

**This European Technical Assessment contains:**

20 pages including 14 annexes which form an integral part of the document

**This European Technical Assessment is issued in accordance with Regulation (EU) No 305/2011, on the basis of:**

EOTA EAD 330499-01-0601, “Bonded fasteners for use in concrete”

**This version replaces:**

Translations of this European Technical Assessment in other languages shall fully correspond to the original issued document and should be identified as such.

Communication of this European Technical Assessment, including transmission by electronic means, shall be in full (except the confidential Annexes referred to above). However, partial reproduction may be made, with the written consent of the issuing Technical Assessment Body. Any partial reproduction has to be identified as such.

## **II SPECIFIC PART OF THE EUROPEAN TECHNICAL ASSESSMENT**

### **1 Technical description of product and intended use**

#### **Technical description of the product**

The AT-HP / AT-HP PLUS / S&P ResAC-19 – which are different trade names for the same product – is a bonded anchor (injection type) for concrete consisting of a cartridge with Simpson Strong-Tie injection mortar and a steel element. The steel element consists of a commercial threaded rod with washer and hexagon nut in the range of M8 to M24 or a reinforcing bar in the range of diameter 8 to 25mm.

The product specification is given in annex A.

The steel element is placed into a drilled hole filled with injection mortar and is anchored via the bond between metal part, injection mortar and concrete.

The characteristic material values, dimensions and tolerances of the anchors not indicated in Annexes shall correspond to the respective values laid down in the technical documentation<sup>1</sup> of this European Technical Assessment.

### **2 Specification of the intended use in accordance with the applicable European Assessment Document (hereinafter EAD)**

The performances given in Section 3 are only valid if the anchor is used in compliance with the specifications and conditions given in Annex B.

The provisions made in this European Technical Assessment are based on an assumed intended working life of the anchor of 50 years.

The indications given on the working life cannot be interpreted as a guarantee given by the producer or Assessment Body, but are to be regarded only as a means for choosing the right products in relation to the expected economically reasonable working life of the works.

---

<sup>1</sup> The technical documentation of this European Technical Assessment is deposited at ETA-Danmark and, as far as relevant for the tasks of the Notified bodies involved in the attestation of conformity procedure, is handed over to the notified bodies.

### **3 Performance of the product and references to the methods used for its assessment**

#### **3.1 Characteristics of product**

##### **Mechanical resistance and stability (BWR 1):**

The essential characteristics are detailed in the Annex C.

##### **Safety in case of fire (BWR 2):**

The essential characteristics are detailed in the Annex C.

##### **Hygiene, health and the environment (BWR3):**

No performance assessed

##### **Safety in use (BWR4):**

For basic requirement Safety in use the same criteria are valid for Basic Requirement Mechanical resistance and stability (BWR1).

Other Basic Requirements are not relevant.

#### **3.2 Methods of assessment**

The assessment of fitness of the anchor for the intended use in relation to the requirements for mechanical resistance and stability and safety in use in the sense of the Basic Requirements 1 and 4 has been made in accordance with EOTA EAD 330499-01-0601, "Bonded fasteners for use in concrete" option 1 and 7.

## **4 Assessment and verification of constancy of performance (AVCP)**

### **4.1 AVCP system**

According to the decision 96/582/EC of the European Commission, the system(s) of assessment and verification of constancy of performance (see Annex V to Regulation (EU) No 305/2011) is 1.

## **5 Technical details necessary for the implementation of the AVCP system, as foreseen in the applicable EAD**

Technical details necessary for the implementation of the AVCP system are laid down in the control plan deposited at ETA-Danmark prior to CE marking.

Issued in Copenhagen on 2023-03-28 by



Thomas Bruun  
Managing Director, ETA-Danmark

**Cartridge: AT-HP / AT-HP PLUS / S&P ResAC-19**

- A) Foil Bag Cartridge 165ml, 300ml.**
- B) Coaxial Cartridge 380ml / 400 ml / 410 ml / 420ml**
- C) Side by Side Cartridge 345ml, 825ml**

Cartridge Print:  
 AT-HP / AT-HP PLUS / S&P ResAC-19  
 Including - Installation procedure,  
 Production Batch code, Expiry Date,  
 Storage conditions, Health & Safety  
 warning, Gel & Cure time according to  
 temperatures.

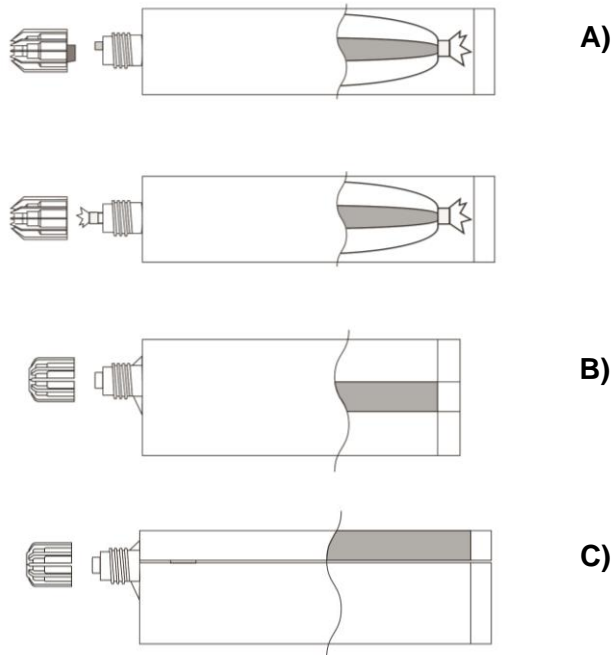

**Marking:**

AT-HP / AT-HP PLUS / S&P ResAC-19  
 Batch code, either expiry date or manufacturing date with shelf life

**Mixer with hanger**

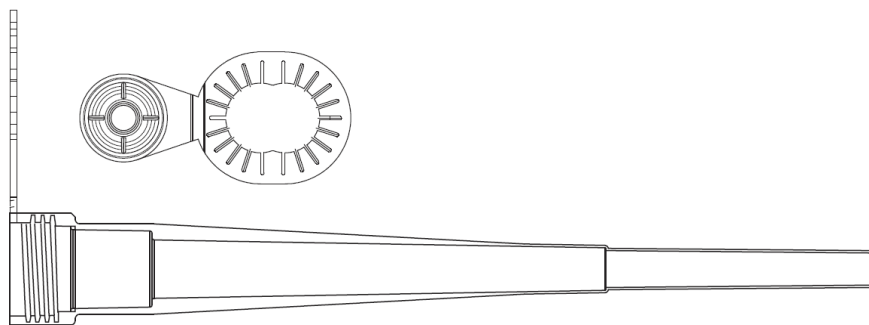

**Mixer**

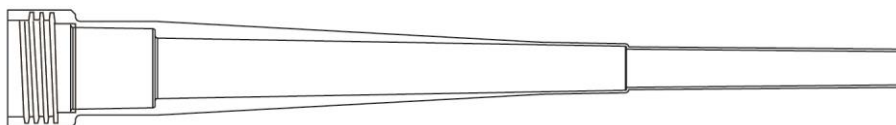

<b>SYSTEM AT-HP / AT-HP PLUS / S&amp;P ResAC-19</b>	<b>Annex A1</b> of European Technical Assessment ETA-23/0253
Product and intended use	

**Anchor rod and rebar**

**Threaded Steel Stud, Nut and Washer**  
 Sizes M8, M10, M12, M16, M20, M24

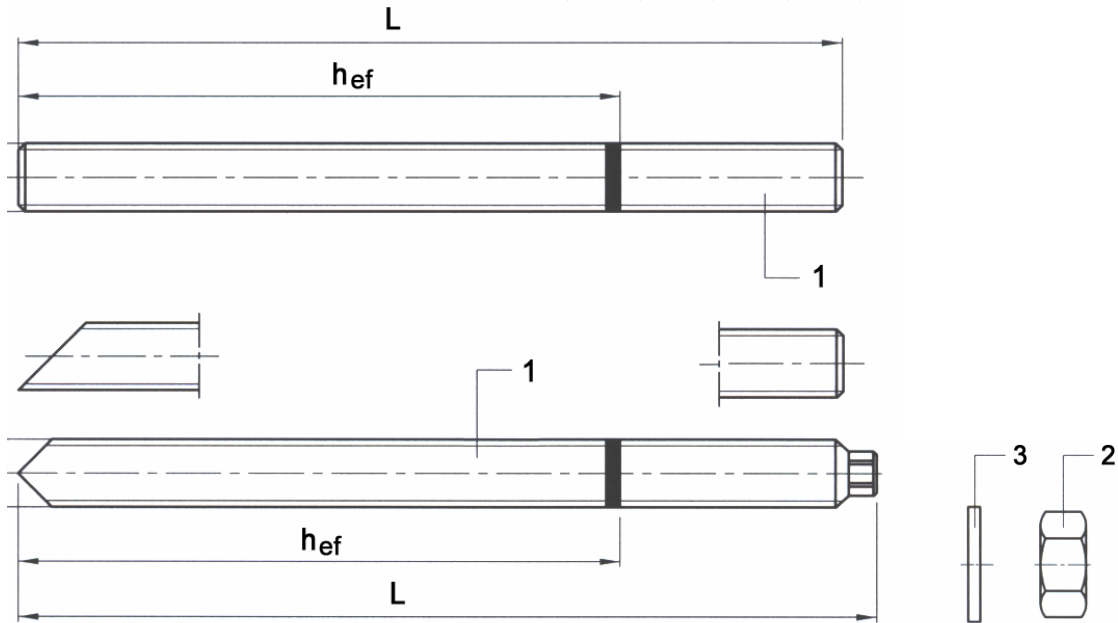

**Rebar**

Diameter Ø 8mm, Ø 10mm, Ø 12mm, Ø 14mm, Ø 16mm, Ø 20mm, Ø 24mm, Ø 25mm,



**SYSTEM AT-HP / AT-HP PLUS / S&P ResAC-19**

Threaded rod types and rebar's dimensions

**Annex A2**  
 of European  
 Technical Assessment  
 ETA-23/0253

## Installed Anchor and Intended Use

**Table A1: Installation details for anchor rods**

Anchor size			M8	M10	M12	M16	M20	M24
Diameter of element	d	[mm]	8	10	12	16	20	24
Range of anchorage depth $h_{ef}$ and bore hole depth $h_o$	min	[mm]	60	60	70	80	90	100
	max	[mm]	96	120	144	192	240	288
Nominal diameter of drill bit	$d_o$	[mm]	10	12	14	18	22	28
Diameter of clearance hole in the fixture	$d_f$	[mm]	9	12	14	18	22	26
Maximum torque moment	$T_{max}$	[Nm]	10	12	20	40	70	90
Minimum thickness of concrete member	$h_{min}$	[mm]	$h_{ef} + 30\text{mm}$ $\geq 100\text{mm}$			$h_{ef} + 2d_o$		
Minimum spacing	$S_{min}$	[mm]	40	40	60	75	95	115
Minimum edge distance	$C_{min}$	[mm]	35	40	45	50	60	65

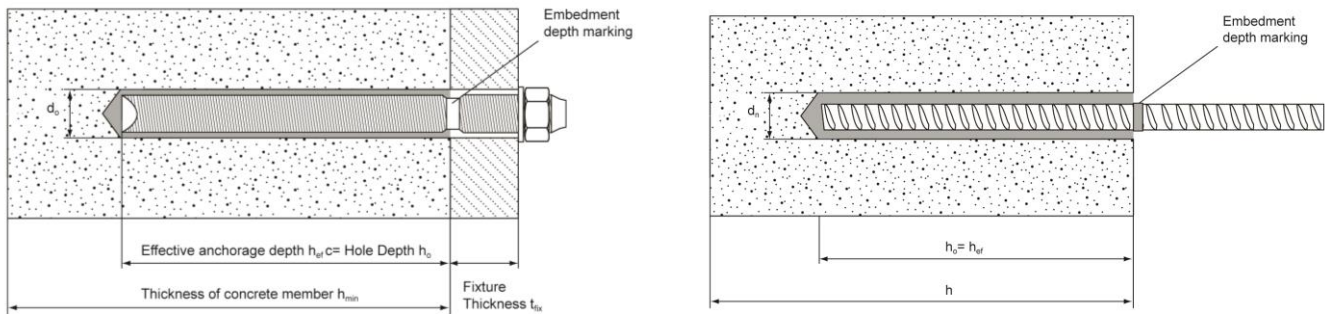

**Table A2: Installation details for rebar**

Rebar size (mm)			$\phi 8$	$\phi 10$	$\phi 12$	$\phi 14$	$\phi 16$	$\phi 20$	$\phi 24$	$\phi 25$
Diameter of element	d	[mm]	8	10	12	14	16	20	24	25
Range of anchorage depth $h_{ef}$ and bore hole depth $h_o$	min	[mm]	60	60	70	75	80	90	100	100
	max	[mm]	96	120	144	168	192	240	288	300
Nominal diameter of drill bit	$D_o$	[mm]	10/12	12/14	14/16	16/18	20	25	28	30
Minimum thickness of concrete member	$h_{min}$	[mm]	$h_{ef} + 30\text{mm}$ $\geq 100\text{mm}$			$h_{ef} + 2d_o$				
Minimum spacing	$S_{min}$	[mm]	40	50	60	70	80	100	120	120
Minimum edge distance	$C_{min}$	[mm]	40	50	60	70	80	100	120	120

**SYSTEM AT-HP / AT-HP PLUS / S&P ResAC-19**

Installation details for threaded studs and rebar

**Annex A3**

of European  
Technical Assessment  
ETA-23/0253



**Table A3: Threaded rod and rebar materials**

<b>Designation</b>	<b>Material</b>
<b>Threaded rods made of zinc coated steel</b>	
Threaded rod M8 – M24	Strength class 4.6 to 12.9 EN ISO 898-1 Steel galvanized $\geq 5\mu\text{m}$ EN ISO 4042 Hot dipped galvanized $\geq 45\mu\text{m}$ EN ISO 10684
Washer ISO 7089	Steel galvanized EN ISO 4042; hot dipped galvanized EN ISO 10684
Nut EN ISO 4032	Strength class 8 EN ISO 898-2 Steel galvanized $\geq 5\mu\text{m}$ EN ISO 4042 Hot dipped galvanized $\geq 45\mu\text{m}$ EN ISO 10684
<b>Threaded rods made of stainless steel</b>	
Threaded rod M8 – M24	Strength class 50, 70 or 80 EN ISO 3506; Stainless steel 1.4401; 1.4404; 1.4578; 1.4571; 1.4439; 1.4362 end 10088
Washer ISO 7089	Stainless steel 1.4401; 1.4404; 1.4578; 1.4571; 1.4439; 1.4362 end 10088
Nut EN ISO 4032	Strength class 70 and 80 EN ISO 3506-1; Stainless steel 1.4401; 1.4404; 1.4578; 1.4571; 1.4439; 1.4362 end 10088
<b>Threaded rods made of high corrosion resistant steel</b>	
Threaded rod M8 – M24	Strength class 70 or 80 $R_m = 800 \text{ N/mm}^2$ ; $R_{p0,2}=640 \text{ N/mm}^2$ High corrosion resistant steel 1.4529, 1.4565 EN 10088
Washer ISO 7089	High corrosion resistant steel 1.4529, 1.4565 EN 10088
Nut EN ISO 4032	Strength class 70 EN ISO 3506-2; High corrosion resistant steel 1.4529, 1.4565 EN 10088
<b>Rebars</b>	
Rebars $\phi 8$ to $\phi 25$	class B and C of characteristic yield strength $f_{yk}$ from 400 MPa to 600 MPa

**SYSTEM AT-HP / AT-HP PLUS / S&P ResAC-19**

Materials

**Annex A4**  
of European  
Technical Assessment  
ETA-23/0253

**Specifications of intended use**

**Anchorage subject to:**

- Static and quasi-static loads: M8 to M24, Rebar Ø8 to Ø25

**Base materials:**

- Reinforced or unreinforced normal weight concrete without fibres according to EN 206:2013 + A1:2016.
- Strength classes C20/25 to C50/60 according to EN 206:2013 + A1:2016.
- Cracked and non-cracked concrete: M8 to M24, Rebar Ø8 to Ø25.

**Temperature Range:**

- I: - 40 °C to +40 °C (max long-term temperature +24 °C and max short-term temperature +40 °C)

**Use conditions (Environmental conditions):**

- Structures subject to dry internal conditions (all materials).
- For all other conditions according to EN 1993-1-4:2006+A1:2015 corresponding to corrosion resistance class:
  - Stainless steel A2 according to Annex A4, Table A1: CRC II
  - Stainless steel A4 according to Annex A4, Table A1: CRC III
  - High corrosion resistance steel HCR according to Annex A4, Table A1: CRC V (for marine environment)

**Design:**



- Verifiable calculation notes and drawings are prepared taking account of the loads to be anchored. The position of the anchor is indicated on the design drawings (e. g. position of the anchor relative to reinforcement or to supports, etc.).
- Anchorages are designed under the responsibility of an engineer experienced in anchorages and concrete work.
- The Anchorages are designed in accordance with:
  - EN 1992-4:2018
  - Technical Report TR055, edition 2018

**Installation:**

- Dry and wet concrete.
- Flooded holes (not sea water).
- Hole drilling by hammer drilling (HD) or compressed air drilling (CD) used in Category 1 (dry and wet concrete) and Category 2 (flooded holes)
- Hole drilling by hollow drill bits for dust free drilling (HDB) (e.g. Bosch self-cleaning system including vacuum cleaner) used in Category 1 – dry and wet concrete
- Overhead installation allowed.
- Anchor installation carried out by appropriately qualified personnel and under the supervision of the person responsible for technical matters of the site.

<b>SYSTEM AT-HP / AT-HP PLUS / S&amp;P ResAC-19</b>	<b>Annex B1</b>
Intended use - Specification	of European Technical Assessment ETA-23/0253

**Table B1: Installation data**

Threaded rod and rebar	Size	Nominal drill bit diameter $d_o$ (mm)	Steel Brush	Cleaning methods		
				Hollow drilling with vacuum cleaner (HDB)	Manual cleaning (MAC)	Compressed air cleaning (CAC)
	M8	10	10 mm	No cleaning needed	$h_{ef} \leq 80$ mm	Yes
	M10	12	12 mm		$h_{ef} \leq 100$ mm	
	M12	14	14 mm		$h_{ef} \leq 120$ mm	
	M16	18	18 mm		$h_{ef} \leq 160$ mm	
	M 20	22	22 mm		$h_{ef} \leq 200$ mm	
	M 24	28	28 mm		$h_{ef} \leq 240$ mm	
	$\phi$ 8 mm	10 or 12	10 or 12 mm	No cleaning needed	$h_{ef} \leq 80$ mm	Yes
	$\phi$ 10 mm	12 or 14	12 or 14 mm		$h_{ef} \leq 100$ mm	
	$\phi$ 12 mm	14 or 16	14 or 16 mm		$h_{ef} \leq 120$ mm	
	$\phi$ 14 mm	16 or 18	16 or 18 mm		$h_{ef} \leq 140$ mm	
	$\phi$ 16 mm	20	20 mm		$h_{ef} \leq 160$ mm	
	$\phi$ 20 mm	24	24 mm		$h_{ef} \leq 200$ mm	
	$\phi$ 24 mm	28	28 mm		$h_{ef} \leq 240$ mm	
	$\phi$ 25 mm	30	30 mm		$h_{ef} \leq 250$ mm	

**Manual Cleaning (MAC):**

Hand pump recommended for Blowing out bore holes with diameters  $d_o \leq 24$  mm and bore holes depth  $h_o \leq 10d$

**Compressed air cleaning (CAC):**

Recommended air nozzle with an Orifice opening of minimum 3,5mm in diameter.

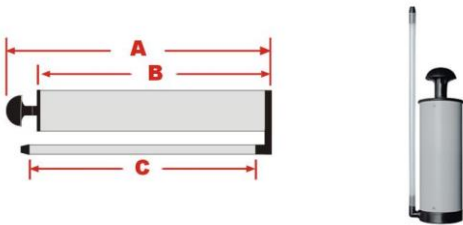

**Hollow Drilling and Vacuum (HDB) (e.g. Bosch®)**



**Steel brush just for manual cleaning and CAC (not needed for HDB)**



**SYSTEM AT-HP / AT-HP PLUS / S&P ResAC-19**

Intended use – data

**Annex B2**  
of European  
Technical Assessment  
ETA-23/0253

**Table B2: Minimum curing time**

Minimum base material temperature C°	Gel time (working time) In dry/wet concrete	Curing time in dry concrete	Curing time in wet concrete or flooded holes
$0^{\circ}\text{C} \leq T_{\text{base material}} < 10^{\circ}\text{C}$	20 min	90 min	180 min
$10^{\circ}\text{C} \leq T_{\text{base material}} < 20^{\circ}\text{C}$	9 min	60 min	120 min
$20^{\circ}\text{C} \leq T_{\text{base material}} < 30^{\circ}\text{C}$	5 min	30 min	60 min
$30^{\circ}\text{C} \leq T_{\text{base material}} \leq 40^{\circ}\text{C}$	3 min	20 min	40 min

The temperature of the bond material must be  $\geq 20^{\circ}\text{C}$

**Resin injection pump details**

Image	Size Cartridge / Code	Type
	165 / 300ml	Manual
	345 / 380 / 400 / 410 / 420ml	Manual
	165 / 300 / 345 / 380 / 400 / 410 / 420ml 7.4v Tool	Battery
	165 / 300 / 380 / 400 / 410 / 420ml	Drill Adaptor
	380 / 400 / 410 / 420 / 825ml	Pneumatic

**SYSTEM AT-HP / AT-HP PLUS / S&P ResAC-19**

Intended use – data

**Annex B3**  
of European  
Technical Assessment  
ETA-23/0253

**Table B3 - parameters: drilling, hole cleaning and installation**

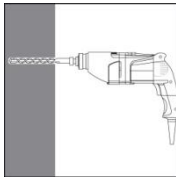
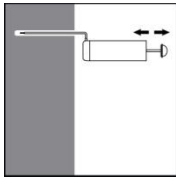
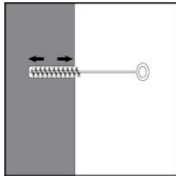
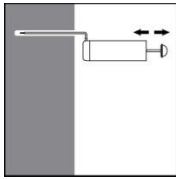
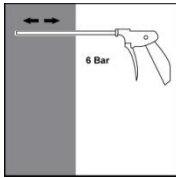
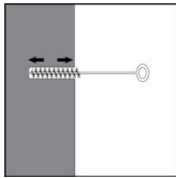
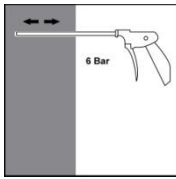
<b>Instructions for use – Hammer drilling (HD) and Compressed air drilling (CD)</b>		
<b>Bore hole drilling</b>		
		Drill hole in the substrate to the required embedment depth using the appropriately sized carbide drill bit.
<b>Bore hole cleaning</b> Just before setting an anchor, the bore hole must be free of dust and debris.		
<b>a) Manual air cleaning (MAC)</b> for all bore hole diameters $d_o \leq 24\text{mm}$ and bore hole depth $h_o \leq 10d$		
	<b>X 4</b>	The manual pump shall be used for blowing out bore holes up to diameters $d_o \leq 24\text{mm}$ and embedment depths up to $h_{ef} \leq 10d$ .  Blow out at least 4 times from the back of the bore hole, using an extension if needed.
	<b>X 4</b>	Brush 4 times with the specified brush size (see Table B1) by inserting the steel brush to the back of the hole (if needed with an extension) in a twisting motion and removing it.
	<b>X 4</b>	Blow out again with manual pump at least 4 times.
<b>b) Compressed air cleaning (CAC)</b> for all bore hole diameters $d_o$ and all bore hole depths		
	<b>X 2</b>	Blow 2 times from the back of the hole (if needed with a nozzle extension) over the whole length with oil-free compressed air (min. 6 bar at $6\text{ m}^3/\text{h}$ ).
	<b>X 2</b>	Brush 2 times with the specified brush size (see Table B1) by inserting the steel brush to the back of the hole (if needed with an extension) in a twisting motion and removing it.
	<b>X 2</b>	Blow out again with compressed air at least 2 times.
<b>SYSTEM AT-HP / AT-HP PLUS / S&amp;P ResAC-19</b>		<b>Annex B3</b> of European Technical Assessment ETA-23/0253
Procedure (1)		

**Instructions for use – Hollow drill bits for dust free drilling**

**Bore hole drilling and cleaning**



Select a suitable hollow drill bit (see table B1) and install it into the hammer drilling machine.  
 Connect the dust extraction system to the aperture in the hollow drill bit. (e.g.: **Bosch**<sup>®</sup> system)  
 Drill hole to the required embedment depth with the hammer drill set in rotation-hammer mode and with the dust extraction system working permanently at full power.

**Bore hole cleaning:** Manual cleaning is not necessary when using the self-cleaning drilling method.

**Table B4 - parameters: After cleaning injection and installation of the stud/rebar**

		<p>Remove the threaded cap from the cartridge. Cut open the foil bag if necessary.</p>
		<p>Tightly attach the Tmixing nozzle. Do not modify the mixer in any way. Make sure the mixing element is inside the mixer. Use only the supplied mixer.</p>
		<p>Insert the cartridge into the dispenser gun.</p>
		<p>Discard the initial trigger pulls of adhesive. Depending on the size of the cartridge, an initial amount of adhesive mix must be discarded. Each time when the mixer is changed, new discard of waste is needed until the colour is homogeneous.  Discard quantities are 10 cm for all cartridges</p>
		<p>Inject the adhesive starting at the back of the hole, slowly withdrawing the mixer with each trigger pull.          Fill holes approximately 2/3 full, to ensure that the annular gap between the anchor and the concrete is completely filled with adhesive along the embedment depth.</p>
		<p>Before use, verify that the threaded rod is dry and free of contaminants.  Install the threaded rod to the required embedment depth during the open gel time <math>t_{gel}</math> has elapsed. The working time <math>t_{gel}</math> is given in Table B2.</p>
		<p>The anchor can be loaded after the required curing time <math>t_{cure}</math> (see Table B2). The applied torque shall not exceed the values <math>T_{max}</math> given in Table A1.</p>

**SYSTEM AT-HP / AT-HP PLUS / S&P ResAC-19**

Procedure (2)

**Annex B4**  
 of European  
 Technical Assessment  
 ETA-23/0253

**Table C1: Characteristic values for steel tension resistance and steel shear resistance of threaded rods**

Size			M8	M10	M12	M16	M20	M24	
Cross section area	A <sub>s</sub>	[mm <sup>2</sup> ]	36.6	58	84.3	157	245	353	
<b>Characteristic tension resistance, Steel failure</b>									
Steel, Property class 4.6 and 4.8	N <sub>Rk,s</sub>	[kN]	15	23	34	63	98	141	
Steel, Property class 5.6 and 5.8	N <sub>Rk,s</sub>	[kN]	18	29	42	78	122	176	
Steel, Property class 8.8	N <sub>Rk,s</sub>	[kN]	29	46	67	125	196	282	
Steel, Property class 10.9	N <sub>Rk,s</sub>	[kN]	37	58	84	157	245	353	
Steel, Property class 12.9	N <sub>Rk,s</sub>	[kN]	44	70	101	188	294	424	
Stainless steel A2, A4 and HCR, Property class 50	N <sub>Rk,s</sub>	[kN]	18	29	42	79	123	177	
Stainless steel A2, A4 and HCR, Property class 70	N <sub>Rk,s</sub>	[kN]	26	41	59	110	171	247	
Stainless steel A4 and HCR, Property class 80	N <sub>Rk,s</sub>	[kN]	29	46	67	126	196	282	
<b>Characteristic tension resistance, Partial factor</b>									
Steel, Property class 4.6 and 5.6	γ <sub>Ms,N</sub> <sup>1)</sup>	[-]	2,0						
Steel, Property class 4.8, 5.8 and 8.8	γ <sub>Ms,N</sub> <sup>1)</sup>	[-]	1,5						
Steel, Property class 10.9 and 12.9	γ <sub>Ms,N</sub> <sup>1)</sup>	[-]	1,4						
Stainless steel A2, A4 and HCR, Property class 50	γ <sub>Ms,N</sub> <sup>1)</sup>	[-]	2,86						
Stainless steel A2, A4 and HCR, Property class 70	γ <sub>Ms,N</sub> <sup>1)</sup>	[-]	1,87						
Stainless steel A4 and HCR, Property class 80	γ <sub>Ms,N</sub> <sup>1)</sup>	[-]	1,6						
<b>Characteristic shear resistance, Steel failure</b>									
Without lever arm	Steel, Property class 4.6 and 4.8	V <sup>0</sup> <sub>Rk,s</sub>	[kN]	7	12	17	31	49	71
	Steel, Property class 5.6 and 5.8	V <sup>0</sup> <sub>Rk,s</sub>	[kN]	9	15	21	39	61	88
	Steel, Property class 8.8	V <sup>0</sup> <sub>Rk,s</sub>	[kN]	15	23	34	63	98	141
	Steel, Property class 10.9	V <sup>0</sup> <sub>Rk,s</sub>	[kN]	18	29	42	79	123	177
	Steel, Property class 12.9	V <sup>0</sup> <sub>Rk,s</sub>	[kN]	22	35	51	94	147	212
	Stainless steel A2, A4 and HCR, Property class 50	V <sup>0</sup> <sub>Rk,s</sub>	[kN]	9	15	21	39	61	88
	Stainless steel A2, A4 and HCR, Property class 70	V <sup>0</sup> <sub>Rk,s</sub>	[kN]	13	20	30	55	86	124
	Stainless steel A4 and HCR, Property class 80	V <sup>0</sup> <sub>Rk,s</sub>	[kN]	15	23	34	63	98	141
With lever arm	Steel, Property class 4.6 and 4.8	M <sup>0</sup> <sub>Rk,s</sub>	[Nm]	15	30	52	133	260	449
	Steel, Property class 5.6 and 5.8	M <sup>0</sup> <sub>Rk,s</sub>	[Nm]	19	37	65	166	324	560
	Steel, Property class 8.8	M <sup>0</sup> <sub>Rk,s</sub>	[Nm]	30	60	105	266	519	896
	Steel, Property class 10.9	M <sup>0</sup> <sub>Rk,s</sub>	[Nm]	37	75	131	333	649	1123
	Steel, Property class 12.9	M <sup>0</sup> <sub>Rk,s</sub>	[Nm]	45	90	157	400	778	1347
	Stainless steel A2, A4 and HCR, Property class 50	M <sup>0</sup> <sub>Rk,s</sub>	[Nm]	19	37	66	167	325	561
	Stainless steel A2, A4 and HCR, Property class 70	M <sup>0</sup> <sub>Rk,s</sub>	[Nm]	26	52	92	232	454	784
	Stainless steel A4 and HCR, Property class 80	M <sup>0</sup> <sub>Rk,s</sub>	[Nm]	30	59	105	266	519	896
<b>Characteristic shear resistance, Partial factor</b>									
Steel, Property class 4.6 and 5.6	γ <sub>Ms,V</sub> <sup>1)</sup>	[-]	1,67						
Steel, Property class 4.8, 5.8 and 8.8	γ <sub>Ms,V</sub> <sup>1)</sup>	[-]	1,25						
Steel, Property class 10.9 and 12.9	γ <sub>Ms,V</sub> <sup>1)</sup>	[-]	1,50						
Stainless steel A2, A4 and HCR, Property class 50	γ <sub>Ms,V</sub> <sup>1)</sup>	[-]	2,38						
Stainless steel A2, A4 and HCR, Property class 70	γ <sub>Ms,V</sub> <sup>1)</sup>	[-]	1,56						
Stainless steel A4 and HCR, Property class 80	γ <sub>Ms,V</sub> <sup>1)</sup>	[-]	1,33						

<sup>1)</sup> in absence of national regulation

**SYSTEM AT-HP / AT-HP PLUS / S&P ResAC-19**

Performance for static and quasi-static loads: Resistances

**Annex C1**  
of European  
Technical Assessment  
ETA-23/0253

<b>Table C2: Characteristic values of tension loads under static and quasi-static for threaded rods</b>									
<b>Anchor size threaded rod</b>			<b>M8</b>	<b>M10</b>	<b>M12</b>	<b>M16</b>	<b>M20</b>	<b>M24</b>	
<b>Steel failure</b>									
Characteristic tension resistance	$N_{Rk,s}$	[kN]	see Table C1						
Partial factor	$\gamma_{Ms,N}$	[-]	see Table C1						
<b>Combined Pull-out and Concrete cone failure <sup>2)</sup></b>									
Characteristic bond resistance in concrete C20/25 – <b>dry or wet</b> concrete for <b>hammer drilling (HD) and CD</b>									
Temperature range 40°C/24°C <b>non-cracked</b> concrete	$\tau_{Rk,ucr}$	[N/mm <sup>2</sup> ]	11	10	10	9,5	9	8,5	
Temperature range 40°C/24°C <b>cracked</b> concrete	$\tau_{Rk,cr}$	[N/mm <sup>2</sup> ]	3,5	3,5	3	3,5	3,5	3,5	
Partial safety factor – dry or wet concrete	$\gamma_{inst}$	[-]	1,2			1,4			
Characteristic bond resistance in non-cracked concrete C20/25 – <b>flooded</b> holes for <b>hammer drilling (HD)</b>									
Temperature range 40°C/24°C <b>non-cracked</b> concrete	$\tau_{Rk,ucr}$	[N/mm <sup>2</sup> ]	11	10	10	9	7,5	7	
Temperature range 40°C/24°C <b>cracked</b> concrete	$\tau_{Rk,cr}$	[N/mm <sup>2</sup> ]	3,5	3,5	3	3,5	3	3	
Partial safety factor – flooded holes	$\gamma_{inst}$	[-]	1,2			1,4			
Characteristic bond resistance in non-cracked concrete C20/25 – <b>dry or wet</b> concrete for <b>hollow drill bits (HDB) – dust free system</b>									
Temperature range 40°C/24°C <b>non-cracked</b> concrete	$\tau_{Rk,ucr}$	[N/mm <sup>2</sup> ]	7	7	7,5	8	8	8,5	
Temperature range 40°C/24°C <b>cracked</b> concrete	$\tau_{Rk,cr}$	[N/mm <sup>2</sup> ]	3,5	3,5	4	3,5	3,5	3,5	
Partial safety factor – dry or wet concrete	$\gamma_{inst}$	[-]	1,2					1,4	
Increasing factor for $\tau_{Rk,ucr}$ in non-cracked for hammer drilling	$\psi_c$	C30/37	1,08					1,00	
		C40/50	1,15					1,00	
		C50/60	1,20					1,00	
Increasing factor for $\tau_{Rk,cr}$ in cracked concrete for hammer drilling	$\psi_c$	C30/37	1,08	1,00					
		C40/50	1,15	1,00					
		C50/60	1,20	1,00					
Increasing factor for $\tau_{Rk,ucr}$ in non-cracked concrete for hollow drilling	$\psi_c$	C30/37	1,00						
		C40/50	1,00						
		C50/60	1,00						
Increasing factor for $\tau_{Rk,cr}$ in cracked concrete for hollow drilling	$\psi_c$	C30/37	1,20	1,00					
		C40/50	1,36	1,00					
		C50/60	1,50	1,00					
Reduction factor in cracked or non-cracked concrete C20/25 for all drilling methods	$\psi_{sus}^0$	[-]	0,794						
Factor for determination of the concrete cone failure	$k_{ucr,N}$	[-]	11,0 (based on concrete cylinder strength $f_{ck}$ )						
Factor for determination of the concrete cone failure	$k_{cr,N}$	[-]	7,7						
Edge distance for concrete cone failure	$c_{cr,N}$	[mm]	1,5 $h_{ef}$						
Axial distance for concrete cone failure	$s_{cr,N}$	[mm]	2 $c_{cr,N}$						
<b>SYSTEM AT-HP / AT-HP PLUS / S&amp;P ResAC-19</b>						<b>Annex C2</b> of European Technical Assessment ETA-23/0253			
Performance for static, quasi-static: Displacements									



**Table C2 : continuation**

Splitting failure <sup>2)</sup>			
Edge distance $c_{cr,sp}$ [mm] for	$h / h_{ef}^{(4)} \geq 2,0$	$1,0 h_{ef}$	
	$2,0 > h / h_{ef}^{(4)} > 1,3$	$3 h_{ef} - 1 h$	
	$h / h_{ef}^{(4)} \leq 1,3$	$1,7 h_{ef}$	
Spacing	$s_{cr,sp}$	[mm]	$2 c_{cr,sp}$

<sup>1)</sup> In absence of national regulations

<sup>3)</sup> Explanations, see annex B1

<sup>2)</sup> Calculation of concrete and splitting, see annex B1

<sup>4)</sup>  $h$  concrete member thickness,  $h_{ef}$  effective anchorage depth

**Table C3: Displacements under tension load**

AT-HP / AT-HP PLUS / S&P ResAC-19 with threaded rods With Hammer drilling (HD) or compressed air drilling (CD)	M8	M10	M12	M16	M20	M24
Temperature range a <sup>5)</sup> : 40°C / 24°C						
Displacement $\delta_{N0}$ [mm/(N/mm <sup>2</sup> )]	0,11	0,11	0,10	0,11	0,12	0,10
Displacement $\delta_{N\infty}$ [mm/(N/mm <sup>2</sup> )]	0,28	0,18	0,82	0,76	0,22	0,30
AT-HP / AT-HP PLUS / S&P ResAC-19 with threaded rods for Hollow drilling HDB (dust-free system)	M8	M10	M12	M16	M20	M24
Temperature range a <sup>5)</sup> : 40°C / 24°C						
Displacement $\delta_{N0}$ [mm/(N/mm <sup>2</sup> )]	0,10	0,12	0,15	0,14	0,14	0,13
Displacement $\delta_{N\infty}$ [mm/(N/mm <sup>2</sup> )]	0,49	0,19	0,38	0,52	0,14	0,19

<sup>5)</sup> Explanation see annex B1

**Table C4: Displacements under shear load for all types of drilling for threaded rods**

AT-HP / AT-HP PLUS / S&P ResAC-19 with threaded rods	M8	M10	M12	M16	M20	M24
Displacement $\delta_{V0}$ [mm/kN]	0,06	0,06	0,05	0,04	0,04	0,03
Displacement $\delta_{V\infty}$ [mm/kN]	0,09	0,08	0,08	0,06	0,06	0,05

**SYSTEM AT-HP / AT-HP PLUS / S&P ResAC-19**

Performance for static, quasi-static and seismic loads: Displacements

**Annex C3**  
of European  
Technical Assessment  
ETA-23/0253

**Table C5: Characteristic values for steel tension resistance and tension load values for rebar**

AT-HP / AT-HP PLUS / S&P ResAC-19 with rebar			φ 8	φ 10	φ 12	φ 14	φ 16	φ 20	φ 24	φ 25	
<b>Steel failure</b>											
Characteristic tension resistance	$N_{Rk,s}$	[kN]	$A_s \cdot f_{uk}^{1)}$								
Cross section area	$A_s$	[mm <sup>2</sup> ]	50	79	113	154	201	314	452	491	
Partial safety factor	$\gamma_{Ms,N}^{2)}$	[-]	1,4								
<b>Combined Pull-out and Concrete cone failure<sup>3)</sup></b>											
Diameter of rebar	$d$	[mm]	8	10	12	14	16	20	24	25	
Characteristic bond resistance in non-cracked concrete C20/25 – dry or wet concrete for <b>hammer drilling (HD) and CD</b>											
Temperature range a <sup>4)</sup> : 40°C/24°C	$\tau_{Rk,ucr}$	[N/mm <sup>2</sup> ]	6	6	6	5,5	5,5	5,5	5,5	5,5	
Partial safety factor – dry or wet concrete	$\gamma_{inst}^{2)}$	[-]	1,2				1,4				
Characteristic bond resistance in non-cracked concrete C20/25 – flooded holes for <b>hammer drilling (HD) and CD</b>											
Temperature range a <sup>4)</sup> : 40°C/24°C	$\tau_{Rk,ucr}$	[N/mm <sup>2</sup> ]	6	6	6	5,5	5,5	4,5	4,5	4,5	
Partial safety factor – flooded holes	$\gamma_{inst}$	[-]	1,2				1,4				
Characteristic bond resistance in non-cracked concrete C20/25 – dry or wet concrete for <b>hollow drill bits (HDB) – dust free system</b>											
Temperature range a <sup>4)</sup> : 40°C/24°C	$\tau_{Rk,ucr}$	[N/mm <sup>2</sup> ]	5	5	5,5	5,5	5,5	5,5	5,5	5,5	
Partial safety factor – dry or wet concrete	$\gamma_{inst}$	[-]	1,2						1,4		
Increasing factor for $\tau_{Rk,ucr}$ in non-cracked concrete	$\psi_c$	C30/37	1,00	1,04	1,08				1,13		
		C40/50	1,00	1,07	1,15				1,23		
		C50/60	1,00	1,10	1,20				1,32		
Factor for determination of the concrete cone failure	$k_{ucr,N}$	[-]	11,0 (based on concrete cylinder strength $f_{ck}$ )								
Factor for determination of the concrete cone failure	$k_{cr,N}$	[-]	7,7								
<b>Splitting failure<sup>3)</sup></b>											
Edge distance $c_{cr,sp}$ [mm] for	$h / h_{ef}^{5)} \geq 2,0$		$1,0 h_{ef}$								
	$2,0 > h / h_{ef}^{5)} > 1,3$		$3 h_{ef} - 1 h$								
	$h / h_{ef}^{5)} \leq 1,3$		$1,7 h_{ef}$								
Spacing	$s_{cr,sp}$	[mm]	$2 c_{cr,sp}$								
<sup>1)</sup> $f_{uk}$ shall be taken from the specifications of reinforcing bars <sup>2)</sup> in absence of national regulation <sup>3)</sup> Calculation of concrete and splitting, see annex B1 <sup>4)</sup> Explanations, see annex B1 <sup>5)</sup> $h$ concrete member thickness, $h_{ef}$ effective anchorage depth											
<b>SYSTEM AT-HP / AT-HP PLUS / S&amp;P ResAC-19</b>								<b>Annex C4</b> of European Technical Assessment ETA-23/0253			
Performance for static and quasi-static loads: Resistances											

**Table C6: Displacements under tension load for rebar**

AT-HP / AT-HP PLUS / S&P ResAC-19 with rebar for hammer drilling (HD) and CD			$\phi$ 8	$\phi$ 10	$\phi$ 12	$\phi$ 14	$\phi$ 16	$\phi$ 20	$\phi$ 24/ $\phi$ 25
Temperature range a <sup>4)</sup> : 40°C / 24°C									
Displacement	$\delta_{N0}$	[mm/(N/mm <sup>2</sup> )]	0,03	0,03	0,04	0,04	0,07	0,07	0,10
Displacement	$\delta_{N\infty}$	[mm/(N/mm <sup>2</sup> )]	0,11	0,11	0,15	0,21	0,26	0,26	0,38
AT-HP / AT-HP PLUS / S&P ResAC-19 with rebar for hollow drilling dust free system (HDB)			$\phi$ 8	$\phi$ 10	$\phi$ 12	$\phi$ 14	$\phi$ 16	$\phi$ 20	$\phi$ 25
Temperature range a <sup>4)</sup> : 40°C / 24°C									
Displacement	$\delta_{N0}$	[mm/(N/mm <sup>2</sup> )]	0,16	0,10	0,03	0,03	0,04	0,04	0,04
Displacement	$\delta_{N\infty}$	[mm/(N/mm <sup>2</sup> )]	0,75	0,45	0,15	0,16	0,17	0,18	0,19

**Table C7: Characteristic steel shear resistance for rebar**

AT-HP / AT-HP PLUS / S&P ResAC-19 with rebar			$\phi$ 8	$\phi$ 10	$\phi$ 12	$\phi$ 14	$\phi$ 16	$\phi$ 20	$\phi$ 25
<b>Steel failure without lever arm</b>									
Characteristic shear resistance	$V_{Rk,s}$	[kN]	$0,50 \cdot A_s \cdot f_{uk}^{1)}$						
Cross section area	$A_s$	[mm <sup>2</sup> ]	50	79	113	154	201	314	491
Partial safety factor	$\gamma_{Ms,N}^{2)}$	[-]	1,5						
<b>Steel failure with lever arm</b>									
Characteristic bending moment	$M^0_{Rk,s}$	[Nm]	$1,2 \cdot W_{el} \cdot f_{uk}^{1)}$						
Elastic section modulus	$W_{el}$	[Nm]	50	98	170	269	402	785	1534
Partial safety factor	$\gamma_{Ms,N}^{2)}$	[-]	1,5						
<b>Concrete pryout failure</b>									
Factor	$k_B$	[-]	1,0		for $h_{ef} < 60\text{mm}$				
			2,0		for $h_{ef} \geq 60\text{mm}$				
Partial safety factor	$\gamma_{Mc}$	[-]	1,5						
<b>Concrete edge failure</b>									
Partial safety factor	$\gamma_{Mc}^{1)}$	[-]	1,5						

<sup>1)</sup>  $f_{uk}$  shall be taken from the specifications of reinforcing bars

<sup>2)</sup> In absence of national regulations

**Table C8: Displacements under shear load for rebar**

AT-HP / AT-HP PLUS / S&P ResAC-19 with rebar			$\phi$ 8	$\phi$ 10	$\phi$ 12	$\phi$ 14	$\phi$ 16	$\phi$ 20	$\phi$ 25
Displacement	$\delta_{V0}$	[mm/kN]	0,05	0,05	0,05	0,04	0,04	0,04	0,03
Displacement	$\delta_{V\infty}$	[mm/kN]	0,08	0,08	0,07	0,06	0,06	0,05	0,05

**SYSTEM AT-HP / AT-HP PLUS / S&P ResAC-19**

Performance for static and quasi-static loads: Resistances

**Annex C5**  
of European  
Technical Assessment  
ETA-23/0253

**Table C9: Resistance to fire**

ESSENTIAL CHARACTERISTICS	PERFORMANCE
Resistance to fire	No performance assessed

**Table C10: Reaction to fire**

ESSENTIAL CHARACTERISTICS	PERFORMANCE
Reaction to fire	In the final application, the thickness of the mortar layer is about 1 to 2 mm and most of the mortar is material classified class A1 according to EC Decision 96/603/EC. Therefore, it may be assumed that the bonding material (synthetic mortar or a mixture of synthetic mortar and cementitious mortar) in connection with the metal anchor in the end use application do not contribute to fire growth or to the fully developed fire and they have no influence on the smoke hazard.

**SYSTEM AT-HP / AT-HP PLUS / S&P ResAC-19**

Performance for exposure to fire

**Annex C6**  
of European  
Technical Assessment  
ETA-23/0253